

A Review Article of Multi-Band, Multi-Mode Microstrip Filters for RF, WLAN, WiMAX, and Wireless Communication by Using Stepped Impedance Resonator (SIR)

Mohammed K. A.* and Ratna K. Z. S.

Center of Excellence of wireless and Photonics Network, Department of Computer and Communication system Engineering, Faculty of Engineering, Universiti Putra Malaysia, 43400 UPM, Serdang, Selangor, Malaysia

ABSTRACT

Filters are the basic part in wired, and wireless telecommunications and radar system circuits and they play an important role in determining the cost and performance of a system. The increasing demand for high performance in the fields of RF, WLAN, WiMAX and other wireless communications led to the great revolution in the advancement of the development of a compact microstrip resonator filter design. All these have made a vital contribution to both the required performance specifications for filters and other commercial requirements in terms of low cost, large storage capacity and high-speed performance. This review paper presents several design examples for multi-band, multi - mode microstrip filter resonators to satisfy RF, WLAN, WiMAX, UWB and other wireless communication frequency bands. To analyse the resonant frequencies odd - mode and even -modes can be used for the symmetrical structure. In general, the multi-mode resonators can be designed by using different methods like cross-coupling resonators Structure, and the allocation of the fundamental resonant frequencies of the resonator as stated by the Chebyshev's insertion loss function.

Keywords: Wireless telecommunication, WLAN, WiMAX, (SIR) filter, multi – mode resonators, UWB (Ultra-Wide Band), cross-coupling resonators

Article history:

Received: 08 January 2016

Accepted: 11 November 2016

E-mail addresses:

mkks67@yahoo.com (Mohammed K. A.),

ratna@upm.edu.my (Ratna K. Z. S.)

*Corresponding Author

INTRODUCTION

A network that provides full transmission of electrical and communication signals with the specific passband region and unlimited attenuation at the stopband regions is called a filter. Filters are main components in an electronic and communication circuits,

especially microstrip filters which are used in the RF/Microwave applications because of their simple structure, ease to fabricate by using simple printed circuit technology, low loss, low cost, and light weight. For reducing the size of the bandpass filter (BPF), a big value substrate of (ϵ_r) should be utilized in spite of it is expensive. To obtain a reduced size (Yoon et al., 2013) and a minor cost, certain types of microstrip resonators can be used for example a U - shape resonator, (SIR) (Stepped Impedance Resonator) (Mahyuddin, Ain, Hassan, & Singh, 2006), and stubs elements, have introduced to design various types of bandpass filters (Cassivi & Wu, 2003)...etc. Surrounded by these public filters, a bandpass filter (BPF) with half-wavelength open stubs appear very wide bandwidth. To achieve a narrow bandwidth (<10%) characteristic of a stub (BPF) design, the stub impedances would be excessively low and the stubs can be very complicated to realize. A narrow bandwidth half - wavelength open stubs bandpass filter can be achieved, it has introduced via fine-tuning the place of stubs by utilizing the (Q_e) where (Q_e) is the external quality factor without any change in the stub impedance (Zhang & Chen, 2006). For further reduction in the horizontal transmission line a narrow bandpass filter with a half - wave length open stubs are proposed. Stepped impedance resonator in many cases can be utilized instead of the transmission line to make a reduction in the physical dimensions of the bandpass filter on the dielectric substrate with low (ϵ_r). This paper offers an easy conventional dual - mode resonator such as a hairpin single - mode resonators. The shape of the resonator degenerates condition with respect to the multi - mode loop microstrip resonator design has rapidly stated in (Tyurnev & Serzhantov, 2011). The split microstrip resonators can be used to design the compact, high selective narrow (BPF). The edge of the O-ring resonator is split by making the O-ring into an open -loop microstrip resonator with the similar resonant frequency (Tyurnev, 2010). The size of the open - loop resonator can be more minimized into a quarter-wavelength to produce a dual - mode resonator by inserting a grounding at the midpoint of the microstrip open - loop resonator (N.-W. Chen & Fang, 2007). The benefit of the quarter-wavelength microstrip resonator is that the even harmonics of the resonator are repressed. The physical dimensions of the quarter-wavelength microstrip resonator has reduced by using a stepped impedance line (Dovbysh & Tyurnev, 2010). A centrally loaded triple - mode resonator (Kunlim, Pinghui, Zhiyuan, & Lin, 2011) is modified to design a third order and a sixth order bandpass filter. Microstrip dual-band bandpass filter represents an important part in an RF/Microwave transceivers for the development of the applications of wireless communication which, working in multi-band, exclusively the recent advanced Wireless Local Area Networks (WLANs) standards like IEEE 802.11b/g (2.4 GHz) and IEEE 802.11a (5.2/5.7 GHz) specifications (Xiao & Huang, 2010). One of the main tasks for the layout of dual-band bandpass filter is to obtain high selectivity in the passband, the small size, in addition, the easy design technique at the same time. In previous, the approaches of many designs have introduced for dual - band bandpass filters [(Xiao & Huang, 2010), (Chu & Chen, 2008)]. The stepped impedance resonators are the best technique has used to transfer the spurious frequencies of the Stepped Impedance Resonators (SIRs) to generate one more passband [(Xiao & Huang, 2010), (Chu & Chen, 2008)]. While there is a difficulty of controlling more than one passband separately by using the (SIR), so the dual passband responses are generated by the two resonator responses at the same time. Lately, we have described a dual - band (BPF) with broad band and narrow band simultaneously (Guo, Yu, & Zhang, 2010).

Conversely, the design technique is complex, meanwhile, the multi-layered technology has been used to invent the four (SIRs). A reduced size of a planar dual – band bandpass filter exploitation a dual structure feeding and embedded resonators have described in (C.-Y. Chen, Hsu, & Chuang, 2006). To realize a dual – band bandpass filter the cascading (SIR) or Stub Loaded Resonator (SLR) which is used, and two resonators, at least, are essential (Xiao & Huang, 2010) - (C.-Y. Chen et al., 2006); Last, for a compact circuit size, the dual-mode resonator develops as, significant applicant and is organized for dual-band application, which needs, at least, one or two resonators. A design process of a triple - mode quasi-planar filter has described in (Kunlim et al., 2011). It was synthesized by inserting a dual – mode microstrip square loop resonator inside a cavity that provides the third resonance (Guo et al., 2010). An incidental metal vase is used to realise the walls of the cavity that joins the top and bottom ground planes. The construction of such a filter is, still, complex and expensive.

SINGLE-BAND, MULTI-MODE MICROSTRIP BANDPASS FILTERS (BPFs)

Stepped Impedance Resonator Open Stub Bandpass Filter for Size Reduction

A half-wavelength narrow band bandpass filter using open-stubs have presented here for more decrease the horizontal transmission line (Yoon et al., 2013)-(Mahyuddin et al., 2006); (C.-Y. Chen et al., 2006). Stepped Impedance Resonator (SIR) can be used instead of transmission line to reduce the size of the bandpass filter on a low substrate. From the research outcomes, the new layout of narrow band (BPF) has reduced in size by a half-length as related to the traditional narrow band (BPF) using the transmission line.

Basic structure of (SIR). (SIR) can be formed of 2 - segments of low impedance at both sides and high impedance in the centre of the structure as illustrated in Figure1(Yoon et al., 2013).

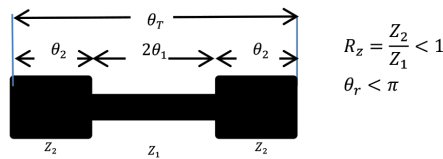

Figure 1. The basic unit structure of the Stepped Impedance Resonator (SIR).

An open-end input admittance Y_{in} is given as (Tyurnev, 2010):

$$Y_i = jY_2 \frac{2(R_z \tan\theta_1 + \tan\theta_2)(R_z - \tan\theta_1 \tan\theta_2)}{R_z(1 - \tan^2\theta_1)(1 - \tan^2\theta_2) - 2(1 - R_z^2 \tan\theta_1 \tan\theta_2)} \quad (1)$$

The conditions of the resonant are $Y_i = 0$ and $R_z = \frac{Z_2}{Z_1} = \tan\theta_1 \tan\theta_2$, where $\theta = \theta_1 = \theta_2$ Eq. (1) Can be simplified as:

$$Y_i = jY_2 \frac{2(R_z + 1)(R_z - \tan^2\theta) \tan\theta}{R_z - 2(1 + R_z + R_z^2) \tan\theta} \quad (2)$$

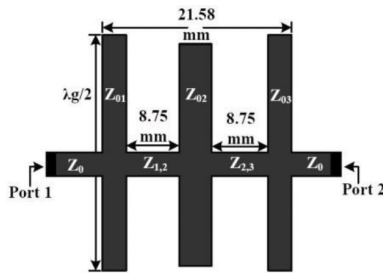

Figure 2. The basic structure of the narrow bandwidth (BPF) with $(\frac{\lambda_g}{2})$ open stubs.

The resonant condition is achieved by:

$$\theta = \theta_0 = \tan^{-1} \sqrt{R_z} \tag{3}$$

The stepped Impedance Resonator (SIR) of the open – circuited half – wavelength $(\frac{1}{2} \lambda_g)$ is estimated to act as a parallel resonant circuit in terms of magnitude of its input impedance $|Z_{in}|$ (Yoon et al., 2013).

Half – Wavelength Open Stub Narrow Bandwidth Bandpass Filter. A bandpass filter (BPF) comprises of shunt half – wavelength open stubs and series quarter wavelength transmission lines (Yoon et al., 2013). Generally, if a bandpass filter with stubs is intended to obtain ($< 10\%$) narrow bandwidth characteristic the impedances of the stubs will be excessively low and the stubs can barely be realized (Tyurnev, 2010). So, this type of bandpass filters maybe an applicant in wideband (BPF) applications (Yoon et al., 2013). The (BPF) proposed in this section, although, has resilience in bandwidth by adjusting the stubs location utilizing the external quality factor (Q_e) and the impedance of the stubs is indicated in Figure 3. Interdigital, combine, and hairpin filters are usually designed to tapped type, in which the location of tapping, (i_t) is the key factor in determining the bandwidth of filters (Mahyuddin et al., 2006). The external quality factor, (Q_e) maybe achieved by the phase response of the stubs ($\omega_c / \Delta\omega \mp 90$) with deviation of the position (l_t) of the open stubs (Yoon et al., 2013) – (Mahyuddin et al., 2006). We can consider (Q_e) as a function of the position of stubs.

Stepped Impedance Resonator (SIR)With New Open Stub (BPF). The introduced narrow bandwidth bandpass filter with half- wavelength open stubs has been decreased in size by half (0.5) as compared with the traditional narrow bandwidth bandpass filter in the horizontal axis as it is seen in Figure 3.

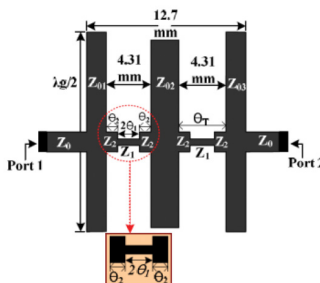

Figure3. size - reduction of the narrow bandwidth (BPF) using (SIR).

Compact Narrow Bandpass Filters Using Dual –Mode Split Microstrip Resonators

Microstrip bandpass filters (BPFs) having dual - mode resonators vary by high selectivity because every dual – mode resonator is identical to a couple of coupled single - mode resonators, i.e., the filter order describing selectivity is a double for a dual – mode filter than for a single – mode filter when they have the same number of resonators. Loop dual – mode microstrip resonators are most favoured (Tyurnev & Serzhantov, 2011)-(Dovbysh & Tyurnev, 2010). Furthermore, they are huge because their width is measurable with the length. Longitudinal and folded stepped – impedance microstrip resonators are better compact (Tyurnev & Serzhantov, 2011). However, the step -impedance technique of the resonant frequency convergence only is not adequate to realise a narrow band dual - mode bandpass filter. In this situation, the impedance step would be quite large and not passable. We propose in this section a plain dual - mode longitudinal microstrip resonator like a single – mode hairpin microstrip resonator. The resonator design is a degenerated state for the design of a multi – mode loop microstrip resonator whose specifications have obviously stated in (N.-W. Chen & Fang, 2007). The split microstrip resonator is suitable for the design of compact, high selectivity narrow - band filters. As an example of one resonator and two – resonator filters are presented.

Dual-Mode Resonator. The dual - mode split microstrip resonator strip conductor has a take shape of a arrow rectangular that is partly being divided by a longitudinal slot at one of its ends. The design and the equivalent circuit of the resonator are illustrated in Figure 4.

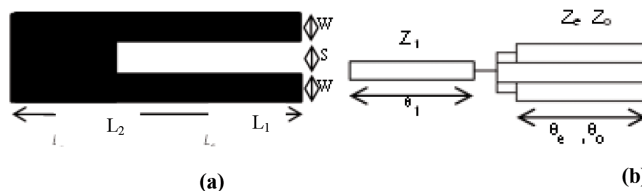

Figure 4. The dual – mode split microstrip resonator (a) the basic unit design (b) the equivalent circuit.

The even oscillation modes of the resonant frequencies are the roots of (4):

$$Z_e \tan \theta_1 + 2Z_1 \tan \theta_e = 0 \tag{4}$$

The odd modes of the resonant frequencies are the roots of the equation:

$$\cos \theta = 0^\circ \tag{5}$$

The currents that pass through the divided conductors run in the same way for even – mode and in the opposite way for the odd - modes. It seems from (5) that the frequencies of odd - modes do not depend on (l_1). From (4) and (5) that the ratio f_e/f_o for the lowest resonant frequencies of the even and the odd - modes are associated with the length ratio l_1/l_2 by the equation:

$$Z_e \tan\left(\frac{\pi f_e}{2 f_o} \sqrt{\frac{\epsilon_1 l_1}{\epsilon_0 l_2}}\right) + 2Z_1 \tan\left(\frac{\pi f_e}{2 f_o} \sqrt{\frac{\epsilon_e}{\epsilon_0}}\right) \quad (6)$$

The coupling coefficient of a symmetrical pair of coupled single-mode resonators (k):

$$k = (f_o^2 - f_e^2)/(f_o^2 + f_e^2) \quad (7)$$

Two resonator filter. The filter of the fourth order has two dual-mode resonators. It means that its frequency response has four reflection minimums and three maximums in the passband. The design of the filter is illustrated in Figure 5. The adjustable structural parameters and its notation are given also.

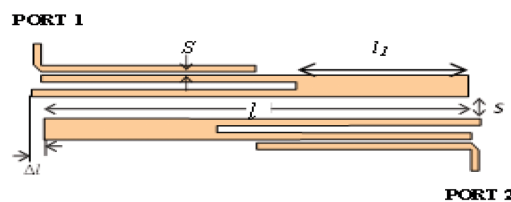

Figure 5. The dual – mode dual - resonator filter design.

The instructions of intelligence, optimization have been used in designing the filter (Dovbysh & Tyurnev, 2010). The tuning of the center frequency fee was used to adjustment of the total resonator length L_t . The symmetrical dual – mode resonator in the two resonator filter is originally not tuned at the specific frequency because its upper and down portions are differently influenced by their edges.

Triple-Mode Compact Microstrip Bandpass Filter resonator Based on Open Stub-Load

A half – wavelength transmission line resonator with a pair of tapping open-ended stubs has used to develop a compact microstrip filter in (Kunlim et al., 2011). In order to repress the first spurious passband a compact microstrip filter using triple - mode stepped impedance resonator (TSIR) is used for this purpose (Xiao & Huang, 2010). A miniature dual – mode microstrip bandpass filter using compact dual – mode hexagonal open – loop resonators with an E – shaped open stub loading is proposed, with the size reduction of about 55% compared with the conventional dual – mode microstrip hexagonal loop filter. The comparison between the Traditional dual – mode microstrip hexagonal loop filter and a miniature dual – mode micro strip bandpass filter using compact dual – mode hexagonal open – loop resonators with an E – shaped open stub loading it is clear that the second type has a size reduction of about 55% (Xiao & Huang, 2010). The resonance specifications of triple-mode open stub – loaded resonator, particularly the main factors which impact the resonance frequencies and the transmission (zeros) positions have come to the fore. In order to achieve compact size, the two open stubs –loaded microstrip lines are folded into E – and T - type, then the method of extracting the coupling structure of a given triple – mode resonator filter is presented.

DUAL-BAND, MULTI-MODE MICROSTRIP BANDPASS FILTERS (BPFS)

Dual-Band Compact Stepped Impedance Resonator (SIR) Bandpass Filter Structure

RF/Microwave filters with dual-band operation [(Xiao & Huang, 2010) - (Guo et al., 2010)] are drawing a lot of attention because the significant increase in desire of wireless communication applications requires RF/Microwave transceivers operating in dual or multi-bands and therefore, the users can approach multiple services slightly with less effort [(Chu & Chen, 2008) -(C.-Y. Chen et al., 2006)]. Stepped Impedance Resonator (SIR) (Xiao & Huang, 2010) -(Guo et al., 2010) was proposed in previous years to replace of conventional half-wavelength Microstrip Parallel- Coupled Resonator (MPCR) because bandpass filters accomplished by (MPCR) have narrow stopband between the fundamental response and the first spurious response, and compared to the conventional (MPCR), stepped impedance resonator not only prevent the spurious responses, but also abridges the resonator dimensions. Dual-band and tri-bandpass filters can be designed by using stepped impedance resonator by tuning the higher order resonant modes. Reference (C.-Y. Chen et al., 2006) stated a bandpass filter using (SIR) with two-path coupling, but, only a single band was obtained. In this section, dual-band bandpass filter is achieved with split ring (SIR) and Defected Ground Structure (DGS) by using two-path coupling. Defected ground structure (DGS) has designed by engraving a defected shape on the metallic ground plane, and this shape increases the efficacious capacitance and inductance of microstrip bar, and as a result, (DGS) prevent the spurious responses by rejecting the harmonics in microwave circuits, and the performance of the filters or other microwave devices are efficiently improved. (DGS) and two-path coupling dual-band (SIR) bandpass filters are proposed in this section, and top performances of transmission zeros, low passband insertion losses, preferred dual-band other than compact structures and size reduction is realized compared with (C.-Y. Chen et al., 2006).

Resonant Characteristics Of Microstrip Stepped-Impedance Resonator (SIR).

Connecting two microstrip transmission lines with different characteristic impedance Z_1 and Z_2 together have formed microstrip Stepped Impedance Resonator (SIR) unit as shown in Figure 6-a (the identical characteristic admittances are Y_1 and Y_2), and the identical electric lengths are θ_1 and θ_2 , respectively. l_1 and l_2 are physical lengths according to electric length θ_1 and θ_2 , respectively. The input impedance Z_i , and the input admittance Y_i . If the intermittent of microstrip step and edge capacitance of open-circuit port are neglected, Z_i has expressed as (Xiao & Huang, 2010):

$$Z_i = jZ_2 \frac{Z_1 \tan \theta_1 + Z_2 \tan \theta_2}{Z_2 - Z_1 \tan \theta_1 \tan \theta_2} \quad (8)$$

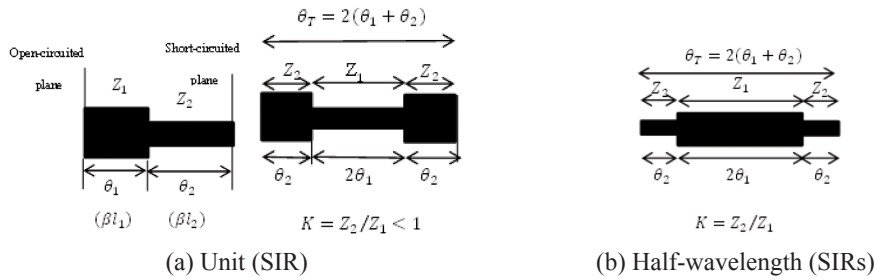

Figure 6. Unit SI and traditional half - wavelength (SIR) structures.

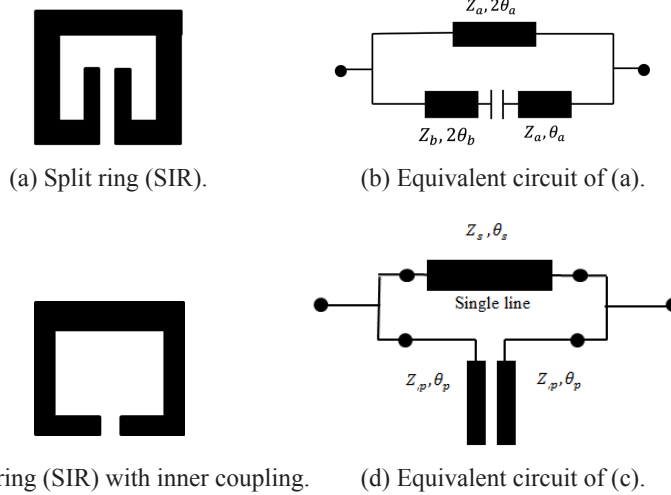

Figure 7. Split ring (SIR) used in the design.

The condition of the parallel resonant has obtained on the rule of: $Y_i = 0$ as $Z_2 - Z_1 \tan \theta_1 \tan \theta_2 = 0$, and, it has been written as:

$$K = \tan \theta_1 \tan \theta_2 = Z_2/Z_1 \tag{9}$$

Where, K is impedance ratio. Figure 6-b shows half-wavelength (SIRs), and their input impedances can be explicit as:

$$Z_{in} = jZ_2 \frac{2(1+K^2)\tan\theta_1\tan\theta_2 - K(1-\tan^2\theta_2)(1-\tan^2\theta_1)}{2(K-\tan\theta_1\tan\theta_2)(\tan\theta_2 + K\tan\theta_1)} \tag{10}$$

The condition of the resonant achieved by $Y_i = 0$ as:

$$K = \tan \theta_1 \tan \theta_2 \tag{11}$$

Split ring (SIRs) is shown in Figures 7-a and 7-c, and their equivalent transmission line models are illustrated in Figures 7-b and 7-d respectively. Split ring (SIR) with inner coupling has formed by using a ring transmission line and end open-circuited parallel coupled lines, and when $\theta_{pe} = \theta_{po} = \theta_p$.

Dual-Band Bandpass Filters with Compact Coupling by Using Split Ring (SIRs). If the first passband has implemented by the first coupling path, and the second passband has implemented by the second coupling path, a required dual-band filter has presented by the two-path coupling. In this section, split ring stepped impedance resonators as illustrated in Figure 7 are selected for coupling in various path. In order to explain the principle of two-path coupling, hairpin (SIR) bandpass filters with 1-path coupling as illustrated in Figures 8, 11 are designed, and Figure 8-b is the equivalent transmission line sample of filter model.

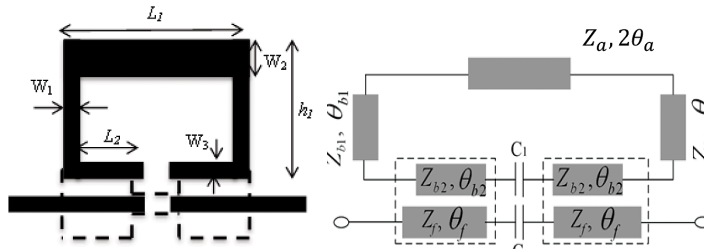

(a) Topology of filter model I. (b) Equivalent transmission line model.

Figure 8. A dual - band (SIR) bandpass filter using one – path coupling.

Design of a Dual-Band, Dual - Mode Bandpass Filter Using Stepped Impedance Resonators

In this section, we present a dual – band, dual – bandpass filter by using (SIRs) with novel coupling structure. It shows that with the new coupling structure the filter has decent passbands specifications. Three transmission zeros have inserted by two stubs added in input/output lines to improve the selectivity.

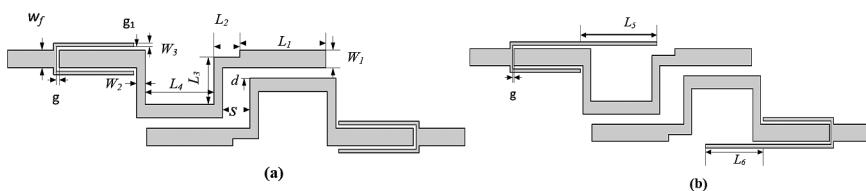

Figure 9. (a) A filter has 1 -transmission zero, 9 (b) A filter have 4 -transmission zeros.

CONCLUSION

In this paper, multi-band, multi-mode an open stub (BPF) with (SIR) has been introduced. The (SIR) can be utilized alternatively of transmission line which pose as an inverter in a traditional open stub (BPF) to minimize the physical dimensions of the (BPF) on the low dielectric substrate. The (BPF’s) inverter had a half – length compared with one of the traditional narrow (BPF). A simple compact dual – mode microstrip resonator having a longitudinal slot

in the one end of its conventional strip conductor is presented. The resonator is perfect for compact narrow band bandpass filters. Two - resonator and three – resonator filters are well - considered. They have transmission zeros in stopbands. The filters offer a high selectivity and small size compared to the filter designs using single – mode resonators. A detailed design steps for a compact triple-mode resonator filter using open stub-loaded has presented in this paper. The design method is simple and the adjustment is effective and quick. In this article, new dual-band bandpass filters with compact structures by using two-path coupling are proposed, and split ring (SIR) and (DGS) are applied not only to reduce the circuit sizes, but also to improve the filter performances of frequency selectivity, harmonic suppression and wide stopband neighbouring the operation passband. A novel dual-mode dual-band filter with (SIRs) is proposed. The newly proposed filter has good passbands performance and is easy to control bandwidths. With introduced two stubs, another three transmissions zeros are created, and the selectivity has further improved. A novel microstrip tri- band bandpass filter has proposed and designed based on stub-loaded triple-mode resonator.

REFERENCES

- Cassivi, Y., & Wu, K. (2003). Low cost microwave oscillator using substrate integrated waveguide cavity. *IEEE Microwave and Wireless Components Letters*, 13(2), 48-50.
- Chen, C. Y., Hsu, C. Y., & Chuang, H. R. (2006). Design of miniature planar dual-band filter using dual-feeding structures and embedded resonators. *IEEE Microwave and Wireless Components Letters*, 16(12), 669-671.
- Chen, N. W., & Fang, K. Z. (2007). An ultra-broadband coplanar-waveguide bandpass filter with sharp skirt selectivity. *IEEE microwave and wireless components letters*, 17(2), 124-126.
- Chu, Q. X., & Chen, F. C. (2008). A compact dual-band bandpass filter using meandering stepped impedance resonators. *IEEE Microwave and Wireless Components Letters*, 18(5), 320-322.
- Dovbysh, I. A., & Tyurnev, V. V. (2010). Synthesis and investigation of three-section microstrip filter on folded dual-mode stepped-impedance resonators. *Progress in Electromagnetics Research M*, 12, 17-28.
- Guo, L., Yu, Z. Y., & Zhang, L. (2010). Design of a dual-mode dual-band filter using stepped impedance resonators. *Progress in Electromagnetics Research Letters*, 14, 147-154.
- Hong, J. S., Shaman, H., & Chun, Y. H. (2007). Dual-mode microstrip open-loop resonators and filters. *IEEE Transactions on Microwave Theory and Techniques*, 55(8), 1764-1770.
- Kunlim, C., Pinghui, L., Zhiyuan, Z., & Lin, F. (2011, May). A novel compact microstrip bandpass filter based on open stub-loaded triple-mode resonator. In *Microwave Technology & Computational Electromagnetics (ICMTCE), 2011 IEEE International Conference on* (pp. 118-121). IEEE.
- Mahyuddin, N. M., Ain, M. F., Hassan, S. I. S., & Singh, M. (2006, September). A 10GHz PHEMT dielectric resonator oscillator. In *2006 International RF and Microwave Conference* (pp. 26-30). IEEE.
- Shen, W., Sun, X. W., & Yin, W. Y. (2009). A novel microstrip filter using three-mode stepped impedance resonator (TSIR). *IEEE Microwave and Wireless Components Letters*, 19(12), 774.
- Tyurnev, V. V. (2010). Coupling coefficients of resonators in microwave filter theory. *Progress in Electromagnetics Research B*, 21, 47-67.

- Tyurnev, V. V., & Serzhantov, A. M. (2011). Dual-mode split microstrip resonator for compact narrowband bandpass filters. *Progress in Electromagnetics Research C*, 23, 151-160.
- Wu, H. W., Liu, S. K., Weng, M. H., & Hung, C. H. (2010). Compact microstrip bandpass filter with multispurious suppression. *Progress in Electromagnetics Research*, 107, 21-30.
- Xiao, J. K., & Huang, H. F. (2010). New dual-band bandpass filter with compact SIR structure. *Progress in Electromagnetics Research Letters*, 18, 125-134.
- Yoon, K. C., Lee, H., Lee, J. G., Park, J. G., Kim, T. Y., Jung, T. S., & Lee, J. C. (2013). Open Stub Band-pass Filter Using Stepped Impedance Resonator for Size Reduction. *Session 2PK*, 873.
- Zhang, H., & Chen, K. J. (2006). Miniaturized coplanar waveguide bandpass filters using multisection stepped-impedance resonators. *IEEE transactions on microwave theory and techniques*, 54(3), 1090-1095.

